

### 1-Line, Bi-directional, Transient Voltage Suppressors

#### Descriptions

The ESD5D600TA is a bi-directional TVS (Transient Voltage Suppressor). It is specifically designed to protect sensitive electronic components that may be subjected to ESD (Electrostatic Discharge), EFT (Electrical Fast Transients) and Lightning. It is particularly well-suited for cellular phones, portable device, digital cameras, power supplies and many other portable applications because of its small package and low weight. The is available in DFN1006-2L package. Standard products are Pb-free and Halogen-free.



DFN1006-2L

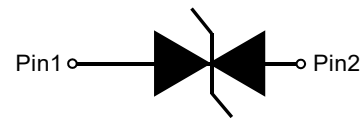

Circuit diagram

#### Features

- Stand-off voltage:  $\pm 5V$  Max
- Transient protection for each line according to IEC61000-4-2 (ESD):  $\pm 30KV$  Air,  $\pm 30 KV$  contact IEC61000-4-5 (Surge): 30 A (8/20 $\mu s$ )
- Solid-state silicon technology
- Low leakage current

#### Applications

- Cell phone handsets and accessories
- Personal Digital Assistants (PDAs)
- Notebooks, Desktops, and Servers
- Portable Instrumentation
- Digital Cameras
- CAR/MID DVD/MP3/MP4/PMP Players

#### Order information

Device	Marking	Package	Shipping
ESD5D600TA	B8	DFN1006-2L	10000/Tape&Reel

### Absolute maximum ratings

Parameter	Symbol	Rating	Unit
Peak pulse current ( $t_p = 8/20\mu s$ )	$I_{PP}$	30	A
ESD according to IEC61000-4-2 air discharge	$V_{ESD}$	$\pm 30$	kV
ESD according to IEC61000-4-2 contact discharge		$\pm 30$	
Operating temperature	$T_{OP}$	-40~85	$^{\circ}C$
Operation junction temperature	$T_J$	125	$^{\circ}C$
Lead temperature	$T_L$	260	$^{\circ}C$
Storage temperature	$T_{STG}$	-55~150	$^{\circ}C$

### Electrical characteristics (TA=25 $^{\circ}C$ , unless otherwise noted)

Parameter	Symbol	Condition	Min.	Typ.	Max.	Unit
Reverse stand-off voltage	$V_{RWM}$				$\pm 5$	V
Reverse leakage current	$I_R$	$V_{RWM} = 5V$			0.5	$\mu A$
Reveres breakdown voltage	$V_{BR}$	$I_T = 1mA$	6.0	6.5	8.0	V
Clamping voltage	$V_C$	$I_{pp} = 1A$ $t_p = 8/20\mu s$		8.5		V
		$I_{pp} = 30A$ $t_p = 8/20\mu s$		10.0	12.0	V
Junction capacitance	$C_J$	$V_R = 0V$ , $f = 1MHz$		60.0	80.0	pF

### Electrical performance curve

$V_{RWM}$  Reverse stand-off voltage

$I_R$  Reverse leakage current

$V_{CL}$  Clamping voltage

$I_{PP}$  Peak pulse current

$V_{TRIG}$  Reverse trigger voltage

$I_{TRIG}$  Reverse trigger current

$V_{BR}$  Reverse breakdown voltage

$I_{BR}$  Reverse breakdown current

$V_{HOLD}$  Reverse holding voltage

$I_{HOLD}$  Reverse holding current

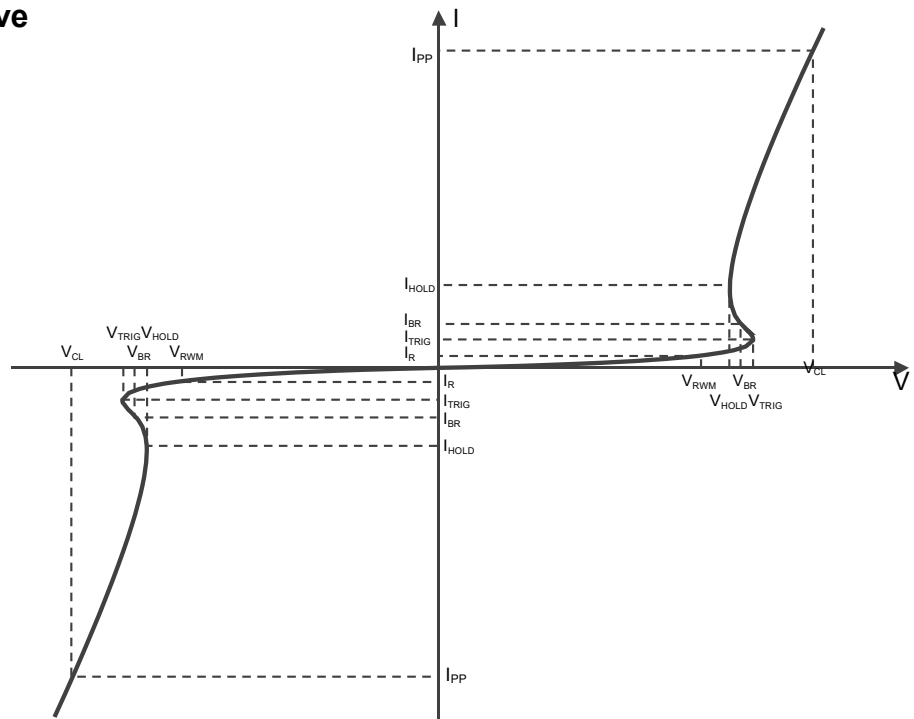

## Typical characteristics ( $T_A=25^\circ\text{C}$ , unless otherwise noted)

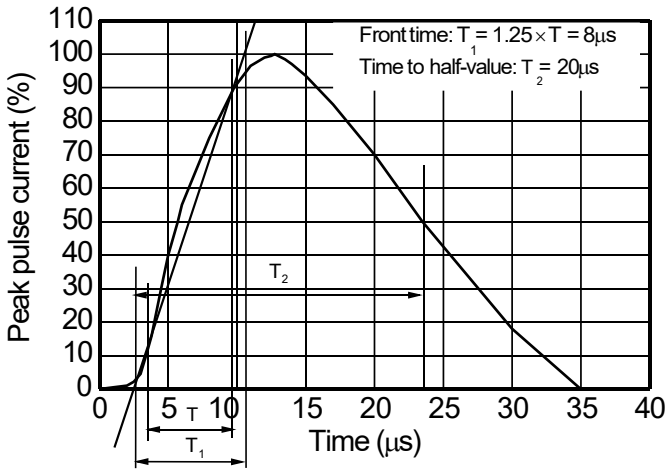

8/20 $\mu\text{s}$  waveform per IEC61000-4-5

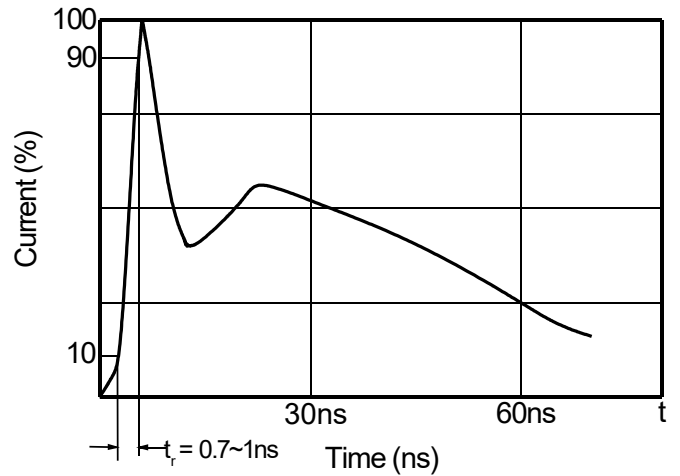

Contact discharge current waveform per IEC61000-4-2

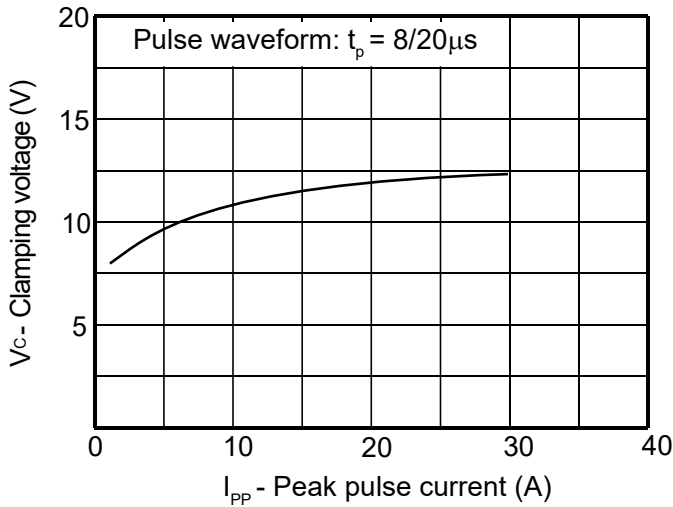

Clamping voltage vs. Peak pulse current

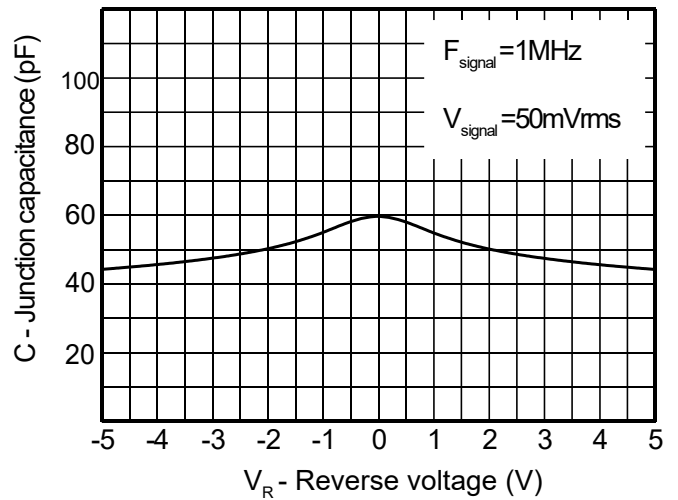

Capacitance vs. Reverse voltage

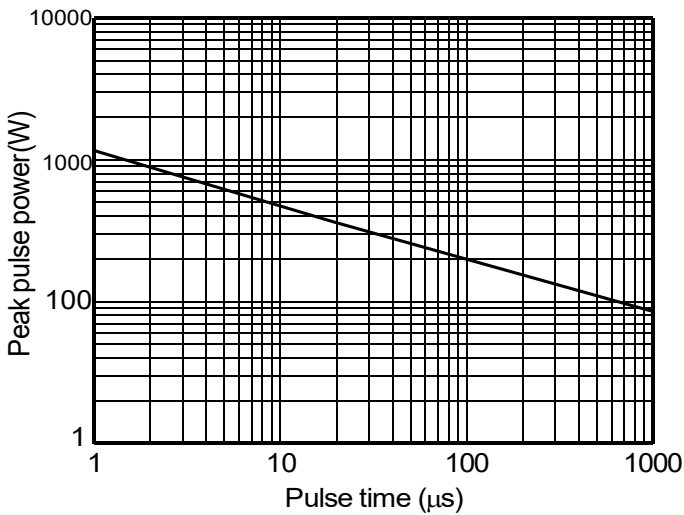

Non-repetitive peak pulse power vs. Pulse time

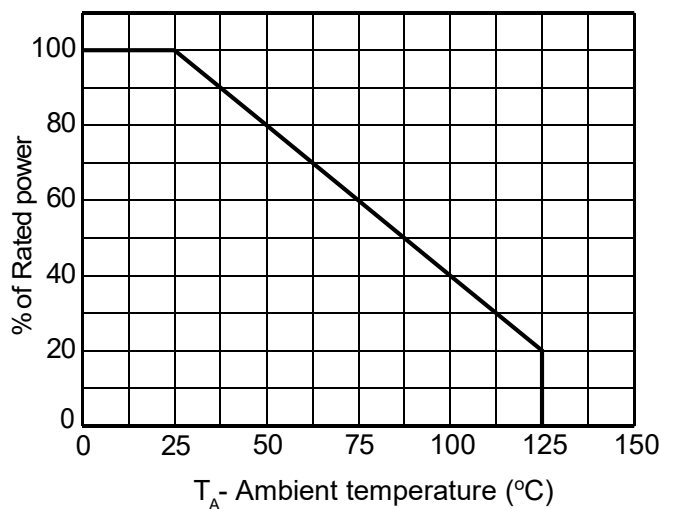

Power derating vs. Ambient temperature

ESD clamping test setup and waveforms

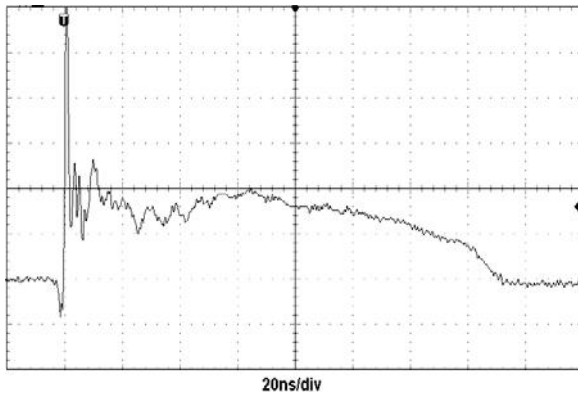
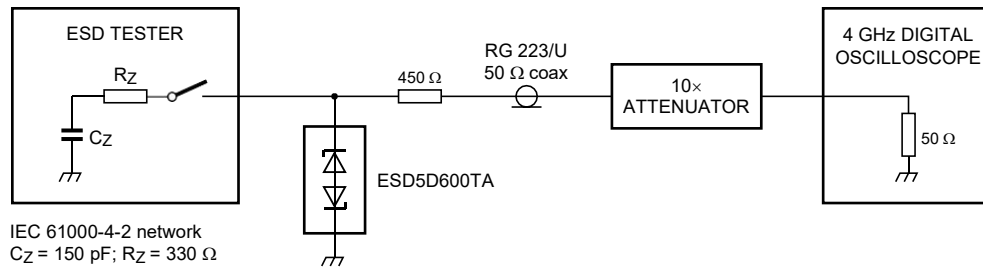

**ESD clamping**  
 (+8kV contact discharge per IEC61000-4-2)

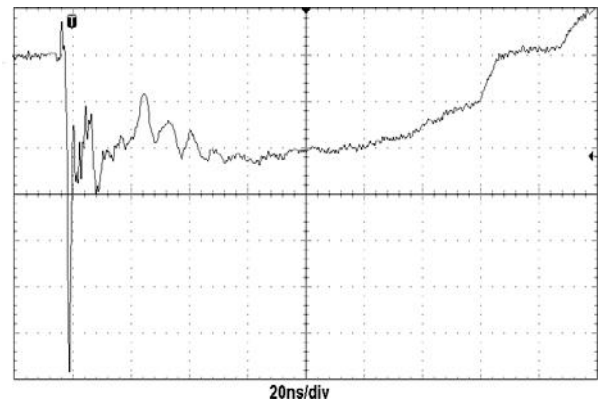

**ESD clamping**  
 (-8kV contact discharge per IEC61000-4-2)

Package outline dimensions

DFN1006-2L

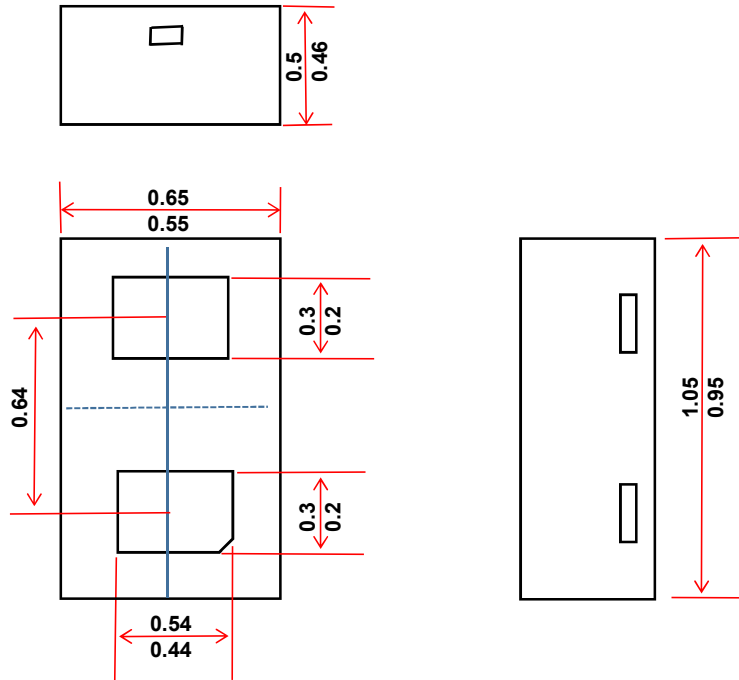

Recommended Mounting Pad Layout Unit:mm

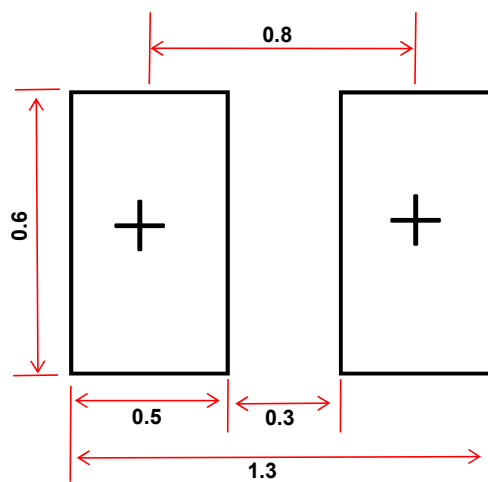

Soldering Parameters

Reflow Condition		Pb-Free assembly (see as bellow)
Pre Heat	-Temperature Min ( $T_{s(min)}$ )	+150°C
	-Temperature Max( $T_{s(max)}$ )	+200°C
	-Time (Min to Max) ( $t_s$ )	60-180 secs.
Average ramp up rate (Liquid us Temp ( $T_L$ ) to peak)		3°C/sec. Max
$T_{s(max)}$ to $T_L$ - Ramp-up Rate		3°C/sec. Max
Reflow	-Temperature( $T_L$ ) (Liquid us)	+217°C
	-Temperature( $t_L$ )	60-150 secs.
Peak Temp ( $T_p$ )		+260(+0/-5)°C
Time within 5°C of actual Peak Temp ( $t_p$ )		30 secs. Max
Ramp-down Rate		6°C/sec. Max
Time 25°C to Peak Temp ( $T_P$ )		8 min. Max
Do not exceed		+260°C

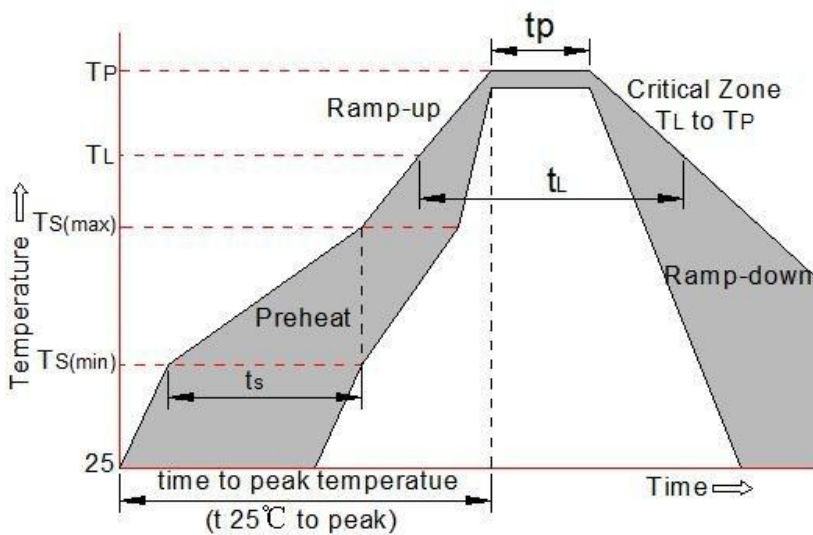

Reel Dimension&Tape Dimension (mm)

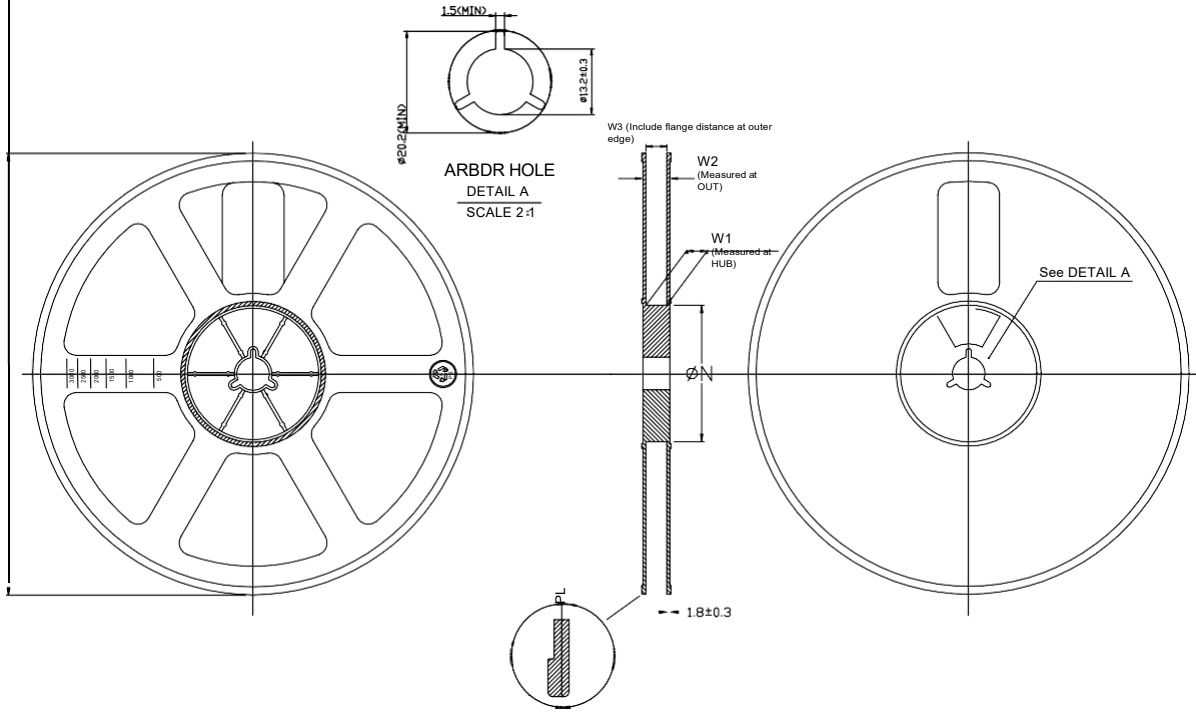

PRODUCT SPECIFICATIONS					
TAPE WIDTH	ØA (±1.0)	ØN (±1.0)	W1 (+2.0/-0.0)	W2 ( MAX)	W3 (+3.0/-0.0)
MM	180	53.6	8.4	14.4	8.4

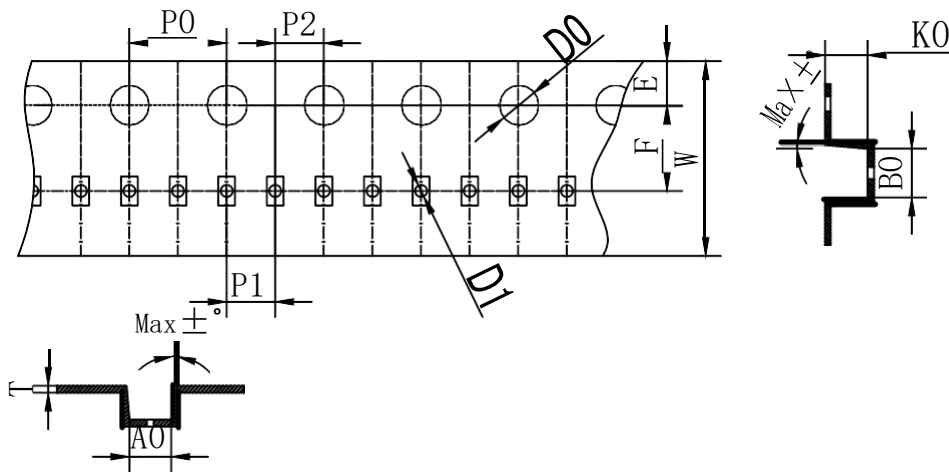

SYMBOL	A0	B0	K0	P0	P1	P2
SPEC	0.68±0.0±	1.1±±0.0±	0.63±0.0±	4.00±0.10	2.00±0.0±	2.00±0.0±
SYMBOL	T	E	F	D0	D1	W
SPEC	0.20±0.03	1.F±±0.10	3.±0±0.0±	1.±±±0.0±	0.50 <sup>+0.1</sup> <sub>-0</sub>	8.00 <sup>+0.2</sup> <sub>-0.1</sub>